

BENCHTOP CENTRIFUGE

— ROTINA 380 | 380 R

HIGH SPEED WITH SPACE SAVING DESIGN

High performance unit supporting a wide array of accessories for multiple applications in just one rotor. Its size and performance make it the ideal bench top centrifuge for most clinical, research and industrial laboratories.

This unit is available with refrigeration and a temperature range from -20 °C to +40 °C (ROTINA 380 R).



— HIGHLIGHTS

- RPM: 50 - 15,000 min⁻¹
Adjustable in increments of 10
- RCF: 50 - 24,400
Adjustable in increments of 1
- max. capacity: 4 x 290 ml
- choice of 9 rotors
- IVDR-conform according to regulation (EU) 2017/746
- max. noise level of 54 dB(A) with rotor 1760
- easy operation with keypad and control knob
- 98 program memories for more individuality
- 9 individual acceleration and 10 deceleration stages
- model 380 R coolable from -20 to +40 °C with pre-cooling function

— FEATURES









- metal housing and lid
- viewing port in the lid
- powered one-hand lid lock
- lid dropping protection
- emergency lid lock release
- stainless steel chamber
- automatic rotor recognition
- brushless drive
- error display
- display in °C and °F possible
- imbalance switch-off
- backlit panel with actual values of all parameters
- auditory message after completion of the centrifugation run

TECHNICAL DATA

	ROTINA 380 non-refrigerated	ROTINA 380 R refrigerated
voltage *)	200 – 240 V 1 ~	200 – 240 V 1 ~
frequency	50 – 60 Hz	50 – 60 Hz
consumption	650 VA	1,300 VA
emission, immunity	EN/IEC 61326-1, class B	EN/IEC 61326-1, class B
max. capacity	4 x 290 ml	4 x 290 ml
max. RPM	15,000 min ⁻¹	15,000 min ⁻¹
max. RCF	24,400	24,400
running time	1 – 99 h: 59 min: 59 sec, ∞ continuous run, short cycle mode	1 – 99 h: 59 min: 59 sec, ∞ continuous run, short cycle mode
dimensions (WxDxH)	457x600x418 mm	457x750x418 mm
weight	approx. 51 kg	approx. 81 kg
noise level	54 dB (A) with rotor 1760	54 dB (A) with rotor 1760
temperature control, infinitely variable	-	from -20 to +40 °C
Cat. No.	1701	1706
100 – 127 V 1 ~ / 50 – 60 Hz *)	1701-01	1706-01
consumption	700 VA	1,400 VA
emission, immunity	FCC class B	FCC class B
weight	approx. 58.5 kg	approx. 88.5 kg

*) Other voltages on request.

AVAILABLE ROTORS

SWING-OUT ROTORS	angle	max. RPM	max. capacity	Cat. No.	page
 swing-out rotor, 4-place	90°	5,000 min ⁻¹	4x290 ml	1754	3
 swing-out rotor, 4-place	90°	4,000 min ⁻¹	4x290 ml	1798	5
 swing-out rotor, 6-place	90°	4,000 min ⁻¹	6x50 ml	1726	8
 swing-out rotor, 2-place	90°	4,000 min ⁻¹	10 plates	1760	9
 swing-out rotor, 2-place	90°	5,100 min ⁻¹	10 plates	1770	9
ANGLE ROTORS					
 angle rotor, 6-place	45°	10,000 l 11,000 min ⁻¹	6x94 ml	1720	10
 angle rotor, 6-place	45°	10,000 l 11,000 min ⁻¹	6x94 ml	1792	11
 angle rotor, 30-place	45°	15,000 min ⁻¹	30x2 ml	1789-A	12

SWING-OUT ROTOR, 4-PLACE | 1754



Rotor

max. RPM max. RCF	5,000 min ⁻¹ 4,863
max. capacity	4 x 290 ml
run-up run-down, braked in sec	42 27
angle max. noise level	90° 60 dB (A)
temperature in °C ¹⁾	0
Cat. No.	1754



Bucket

lid bioseal ⁵⁾	1751
Cat. No.	1752



Vessels

capacity in ml	1.5	2.0	3	4	5	6	7	9	15	20	25	45	50	94	100
Ø x L in mm	11 x 38	11 x 38	10 x 60	12 x 60	12 x 75	12 x 82	12 x 100	14 x 100	17 x 100	21 x 100	24 x 100	31 x 100	34 x 100	38 x 106	40 x 115
max. RCF ²⁾	3,494 / 4,779	3,494 / 4,779	4,779	4,668	4,668	4,668	4,668	4,668	4,668	4,668	4,668	4,668	4,668	4,807	4,640
radius in mm	125 / 171	125 / 171	171	167	167	167	167	167	167	167	167	167	167	172	166
Cat. No.	microliter tubes			tubes²⁾											



Adapter

boring Ø x L in mm	11.2x39.5	11.2x39.5	11.2x39.5	12.5x56	12.5x56	12.5x56	12.5x56	17.5x62	17.5x62	25.5x81	25.5x81	35.5x81	35.5x81	38.5x80	41 x 97
vessels per rotor	144	144	72	96	96	96	96	52	52	24	24	12	12	8	4
Cat. No.	1761	1761	1761	1762-A	1762-A	1762-A	1762-A	1763-A	1763-A	1764	1764	1765	1765	1777	1767

Vessels

capacity in ml	100	250	1.1-1.4	2.6-2.9	2.7-3	4.5-5	4.5-5	4.5-5	4.9	4.9	7.5-8.2	9-10	10	1.6-5	4-7
Ø x L in mm	44 x 100	65 x 115	8 x 66	13 x 65	11 x 66	15 x 75	11 x 92	11 x 92	13 x 90	13 x 90	15 x 92	16 x 92	15 x 102	13 x 75	13 x 100
max. RCF ²⁾	4,640	4,640	4,668	4,668	4,668	4,668	4,668	4,668	4,668	4,668	4,668	4,668	4,668	4,668	4,668
radius in mm	166	166	167	167	167	167	167	167	167	167	167	167	167	167	167
Cat. No.	tubes²⁾		blood collection tubes / urine tubes												



Adapter

boring Ø x L in mm	45 x 87	66 x 104.5	9 x 49	13.5 x 54	12.5 x 56	17.5 x 62	12.5 x 56	13.2 x 72	13.5 x 54	13.2 x 72	17.5 x 62	17.5 x 62	17.5 x 62	13.5 x 54	13.5 x 54
vessels per rotor	4	4	96	64	96	52	96	76	64	76	52	52	52	64	64
Cat. No.	1766	1768	1781	1783-A	1762-A	1763-A	1762-A	1787	1783-A	1787	1763-A	1763-A	1763-A	1783-A	1783-A















1) For cooled versions: Lowest temperature achievable with precooling and max. speed.
 2) Please note that the RCF values indicated refer only to rotor performance. The max. permissible RCF of tubes used should be verified with the individual manufacturers. The max. RCF for glass tubes annotated with footnote 2) is 4,000.
 5) Tested by TÜV in conformity with DIN EN 61010, section 2-020.















SWING-OUT ROTOR, 4-PLACE | 1754









Rotor	
max. RPM max. RCF	5,000 min ⁻¹ 4,863
max. capacity	4 x 290 ml
run-up run-down, braked in sec	42 27
angle max. noise level	90° 60 dB (A)
temperature in °C ¹⁾	0
Cat. No.	1754









Bucket	
lid bioseal ⁵⁾	1751
Cat. No.	1752



Vessels															
capacity in ml	4 – 7	4 – 7	8	8.5 – 10	5	15	50	12	25	30	50	50	14	10	30
Ø x L in mm	13x100	16x75	16x125	16x100	17x59	17x120	29 x 115	17x100	25x90	25x110	29x115	29x115	16,5x106	16x80	26x95
max. RCF ²⁾	4,668	4,668	4,668	4,668	4,863	4,863	4,863	4,696	4,528	4,528	4,752	4,752	4,668	4,668	4,807
radius in mm	167	167	167	167	174	174	174	168	162	162	170	170	167	167	172
Cat. No.	blood collection tubes / urine tubes				-	tubes with screw cap									

Adapter																
boring Ø x L in mm	13.2x72	17.5x62	17.5x62 ²¹⁾	17.5x62	17x52	17x84	30x84	17x78	26.5x72	26.5x72	30x80	30x80	30x80	17.5x62	17.5x62	26.5x70
vessels per rotor	76	52	12	52	32	36	16	36	20	20	16	16	16	52	52	24
Cat. No.	1787	1763-A	1763-A	1763-A	1738	1771-A	1772-A	1773	1779	1779	1774-A	1774-A	1774-A	1763-A	1763-A	1775

Vessels									
capacity in ml	50	85	94	175	175 ^{3.3)}	200	225	250	290 ^{3.3)}
Ø x L in mm	29x107	38x106	38x106	61 x 118	62 x 144	60 x 130	61 x 137	62 x 122	62 x 137
max. RCF ²⁾	4,752	4,807	4,807	4,863	4,863	4,863	4,863	4,863	4,863
radius in mm	170	172	172	174	174	174	174	174	174
Cat. No.	tubes with screw cap			Falcon	Nalgene	Nunc®	Falcon	5127²⁴⁾	-²⁴⁾

Adapter									
boring Ø x L in mm	30 x 80	38.5 x 80	38.5 x 80	62 x 111	62 x 111	62 x 111	62 x 111	62 x 100	62 x 100
vessels per rotor	16	8	8	4	4	4	4	4	4
Cat. No.	1774-A	1777	1777	1782	1778	1778	1782	1769	1769

1) For cooled versions: Lowest temperature achievable with precooling and max. speed.
 2) Please note that the RCF values indicated refer only to rotor performance. The max. permissible RCF of tubes used should be verified with the individual manufacturers. The max. RCF for glass tubes annotated with footnote 2) is 4,000.
 3.3) When using these tubes, bucket 1752 or 5051 cannot be closed with lid 1751 or 5053.
 5) Tested by the TÜV in conformity with DIN EN 61010, section 2-020.
 21) Adapter must be loaded as illustrated.
 24) At temperatures of over +40 °C and / or when not filled to capacity, bottles may warp during centrifugation.

SWING-OUT ROTOR, 4-PLACE | 1798

Rotor	
max. RPM max. RCF	4,000 min ⁻¹ 2,898
max. capacity	4 x 100 ml
run-up run-down, braked in sec	24 17
angle max. noise level	90° 55 dB (A)
temperature in °C ¹⁾	-8
Cat. No.	1798

Bucket	
lid	5053
Cat. No.	5051



Vessels	
capacity in ml	1.5 2 1.5 2 3 5 6 7 9 15 25 50 100 100
Ø x L in mm	11x38 11x38 11x38 11x38 10x60 12x75 12x82 12x100 14x100 17x100 24x100 34x100 40x115 44x100
max. RCF ²⁾	1,950 / 2,826 1,950 / 2,826 2,826 2,826 2,737 2,773 2,773 2,755 2,773 2,755 2,755 2,755 2,755 2,755
radius in mm	109 / 158 109 / 158 158 158 153 155 155 155 154 155 154 154 154 154
Cat. No.	microliter tubes tubes²⁾

Adapter	
boring Ø x L in mm	12.5x37 12.5x37 11.5x50 11.5x50 11 x 41.5 12.5x39.5 12.5x39.5 12.5x82.5 16x47.5 17.5x82.5 26x82.5 36x82.5 42x86 45.5x86
vessels per rotor	160 160 64 64 80 80 80 80 48 48 20 8 4 4
Cat. No.	5257 5257 5281 5281 5267 5227 5227 5247¹⁵⁾ 5264 5248¹⁵⁾ 5242 5243 5249 5262

Vessels	
capacity in ml	1.1–1.4 2.6–2.9 2.7–3 4–5.5 4.5–5 4.9 7.5–8.2 9–10 10 1.6–5 4–7 4–7 8.5–10
Ø x L in mm	8x66 13x65 11 x 66 15 x 75 11 x 92 13x90 15x92 16x92 15x102 13x75 13x100 16x75 16x100
max. RCF ²⁾	2,737 2,808 2,773 2,773 2,773 2,808 2,773 2,755 2,755 2,808 2,808 2,773 2,755
radius in mm	153 157 155 155 155 157 155 154 154 157 157 155 154
Cat. No.	blood collection tubes / urine tubes

Adapter	
boring Ø x L in mm	11 x 41.5 13.5x49.5 12.5x39.5 16x47.5 12.5x39.5 13.5x49.5 16x47.5 17.6x82.5 17.6x82.5 13.5x49.5 13.5x49.5 16x47.5 17.5x82.5
vessels per rotor	80 48 80 48 80 48 48 44 44 48 48 48 48
Cat. No.	5267 5268 5227 5264 5227 5268 5264 5258 5258 5268 5268 5264 5248

Vessels	
capacity in ml	30 50 15 12 30 50 1–8
Ø x L in mm	25x110 29x115 17x120 17x100 25x110 29x115 simple / multiple
max. RCF ²⁾	2,755 2,826 2,898 2,898 2,755 2,755 1,735 / 2,737
radius in mm	154 158 162 162 154 154 97 / 153
Cat. No.	tubes with screw cap cyto chambers

CYTO Cyto system available for this model. More information on page 178

Adapter	
boring Ø x L in mm	26x82.5 30x90 17.2x90 17.2x90 26x82.5 36x82.5 -
vessels per rotor	20 8 28 28 20 8 8
Cat. No.	5266 5259 6306 6306 5266 5243 5280





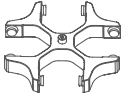



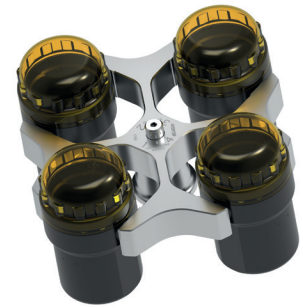





1) For cooled versions: Lowest temperature achievable with precooling and max. speed.
 2) Please note that the RCF values indicated refer only to rotor performance. The max. permissible RCF of tubes used should be verified with the individual manufacturers. The max. RCF for glass tubes annotated with footnote 2) is 4,000.
 3.3) When using these tubes, bucket 1752 or 5051 cannot be closed with lid 1751 or 5053.
 15) Also available with decanting aid. (Cat. No. 5247-91 or 5248-91).

















— SWING-OUT ROTOR, 4-PLACE | 1798

















Rotor	
max. RPM max. RCF	4,000 min ¹⁾ 3,095
max. capacity	4x 290 ml
run-up run-down, braked in sec	24 17
angle max. noise level	90° 56 dB (A)
temperature in °C ¹⁾	-8
Cat. No.	1798

















Bucket	
lid bioseal ⁵⁾	5093
Cat. No.	5092





Vessels															
capacity in ml	5	6	7	15	25	50	100	100	250	15	30	50	12	25	30
Ø x L in mm	12x75	12x82	12x100	17x100	24x100	34x100	44x100	40x115	65x115	17x120	25 x 110	29x115	17x100	25x90	25x110
max. RCF ²⁾	3,005	3,005	3,005	2,952	2,898	2,952	2,952	2,952	3,095	3,095	2,898	3,095	3,005	2,826	2,898
radius in mm	168	168	168	165	162	165	165	165	173	173	162	173	168	158	162
Cat. No.	tubes²⁾									tubes with screw cap					

Adapter																
boring Ø x L in mm	12.8x42	12.8x42	12.8x79.5	17.5x56.7	25.5x74	35.5x77.5	45.5x76.5	42x76.5	65x103	17x74	25.5x82	30x85	17.5x79.5	26x73	25.5x74	
vessels per rotor	48	48	48	32	16	4	4	4	4	28	16	8	28	12	16	
Cat. No.	5128	5128	5120	5136	5122	5124	5125	5126	1791	5129	5122	5123	5121	5134	5122	

Vessels																
capacity in ml	50	10	250	290	1.1-1.4	2.7-3	4-4.5	4.9	7.5-8.2	9-10	10	1.6-5	4-7	4-7	8	
Ø x L in mm	29x115	16 x 80	61 x 122	62 x 137	8 x 66	11x66	15x75	13x90	15x92	16x92	15x102	13x75	16x75	13x100	16x125	
max. RCF ²⁾	3,023	2,952	3,095	3,095	2,952	2,952	2,952	2,952	2,952	2,952	2,952	2,952	2,952	3,005	3,059	
radius in mm	169	165	173	173	165	165	165	165	165	165	165	165	165	168	171	
Cat. No.	tubes with screw cap			5127²⁴⁾	-²⁴⁾	blood collection tubes / urine tubes										

Adapter																
boring Ø x L in mm	30x99	17.5x56,7	63x90	63x90	12,8x54,5	12,8x54,5	17,5x56,7	17,5x56,7	17,5x56,7	17,5x56,7	17,5x56,7	17,5x56,7	12,8x54,5	17,5x56,7	12,8x79,5	17,5x79,5
vessels per rotor	8	32	4	4	48	48	32	32	32	32	32	32	48	32	48	28
Cat. No.	5135	5136	6319	6319	5138	5138	5136	5137	5136	5136	5136	5136	5138	5136	5120	5121⁹⁾

Vessels	
capacity in ml	8.5 - 10
Ø x L in mm	16x100
max. RCF ²⁾	2,952
radius in mm	165
Cat. No.	-

Adapter	
boring Ø x L in mm	17.5x56.7
vessels per rotor	32
Cat. No.	5136

- 1) For cooled versions: Lowest temperature achievable with precooling and max. speed.
- 2) Please note that the RCF values indicated refer only to rotor performance. The max. permissible RCF of tubes used should be verified with the individual manufacturers. The max. RCF for glass tubes annotated with footnote 2) is 4,000.
- 3.5) When using these tubes, bucket 5092 cannot be closed with lid 5053.
- 4) Please remove the spacer.
- 5) Tested by the TÜV in conformity with DIN EN 61010, section 2-020.
- 24) At temperatures of over +40 °C and / or when not filled to capacity, bottles may warp during centrifugation.

— SWING-OUT ROTOR, 6-PLACE | 1726

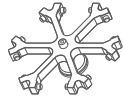

Rotor	
max. RPM max. RCF	4,000 min ⁻¹ 2,808
max. capacity	6 x 50 ml
run-up run-down, braked in sec	19 18
angle temperature in °C ¹⁾	90° -6
Cat. No.	1726



Vessels													
capacity in ml	5	5	6	7	9	15	20	25	45	50	8.5–10	30	1–8
Ø x L in mm	12x75	12x75	12x82	12x100	14x100	17x100	21x100	24x100	31x100	34x100	16x100	26x95	simple / multiple
max. RCF ²⁾	2,576	2,522	2,665	2,665	2,665	2,665	2,719	2,808	2,719	2,808	2,665	2,808	2,003
radius in mm	144	141	149	149	149	149	152	157	152	157	149	157	112

Cat. No.	tubes ²⁾											-	-	cyto chambers
-----------------	---------------------	--	--	--	--	--	--	--	--	--	--	---	---	---------------

Carrier													
boring Ø x L in mm	12.5x74	14.5x63	12.5x74	12.5x74	14.6x74	17.6x74	21.5x74	25x78	32x74	35x78	17.6x74	25x78	-
vessels per rotor	24	102	24	24	30	24	12	12	6	6	24	12	6
Cat. No.	1369-91	1372	1369-92	1369-92	1370	1369	1346	1745	1345	1746	1369	1745	1660

CYTO Cyto system available for this model. More information on page 180

— SWING-OUT ROTOR, 6-PLACE | 1726



Rotor	
max. RPM max. RCF	4,000 min ⁻¹ 2,808
max. capacity	42 x 15 ml
run-up run-down, braked in sec	19 18
angle max. noise level	90° 54 dB (A)
temperature in °C ¹⁾	-6
Cat. No.	1726

Carrier	
Cat. No.	1742



Vessels										
capacity in ml	15	2.6–2.9	4–4.5	7.5–8.2	9–10	10	1.6–5	4–7	8.5–10	15
Ø x L in mm	17x100	13x65	15x75	15x92	16x92	15x102	13x75	16x75	16x100	17x120
max. RCF ²⁾	2,808	2,683	2,683	2,808	2,808	2,808	2,683	2,683	2,808	2,808
radius in mm	157	150	150	157	157	157	150	150	157	157
Cat. No.	- ²⁾	blood collection tubes / urine tubes								-

Spacer										
boring Ø x L in mm	17.6 x 78	17.6 x 78	17.6 x 78	17.6 x 78	17.6 x 78	17.6 x 78	17.6 x 78	17.6 x 78	17.6 x 78	17.6 x 78
vessels per rotor	42	42	42	42	42	18	42	42	42	18
Cat. No.	-	0716	0716	-	-	-	0716	0716	-	-

- 1) For cooled versions: Lowest temperature achievable with precooling and max. speed.
 - 2) Please note that the RCF values indicated refer only to rotor performance. The max. permissible RCF of tubes used should be verified with the individual manufacturers. The max. RCF for glass tubes annotated with footnote 2) is 4,000.
- 21) Adapter must be loaded as illustrated.

— SWING-OUT ROTOR, 6-PLACE | 1726



Rotor	
max. RPM max. RCF	4,000 min ⁻¹ 2,325
max. capacity	72 x 4 ml
run-up run-down, braked in sec	19 18
angle max. noise level	90° 54 dB (A)
temperature in °C ¹⁾	-6
Cat. No.	1726



Bucket	
Cat. No.	1366



Vessels	
capacity in ml	1.5 2.0 1 3 4
Ø x L in mm	11 x 38 11 x 38 6 x 45 10 x 60 12 x 60
max. RCF ²⁾	2,325 2,325 2,308 2,290 2,290
radius in mm	130 130 129 128 128
Cat. No.	microliter tubes Rhesus tubes²⁾



Adapter	
boring Ø x L in mm	11.5 x 38 11.5 x 38 6.5 x 23 10.5 x 23 12.5 x 42
vessels per rotor	54 54 180 72 72
Cat. No.	5277 5277 1357 1327 1326



— SWING-OUT ROTOR, 6-PLACE | 1726



Rotor	
max. RPM max. RCF	4,000 min ⁻¹ 2,808
max. capacity	60 x 9 ml
run-up run-down, braked in sec	19 18
angle max. noise level	90° 54 dB (A)
temperature in °C ¹⁾	-6
Cat. No.	1726



Carrier	
Cat. No.	1741



Vessels	
capacity in ml	9 1.1 – 1.4 4.5 – 5 4.9 4 – 7
Ø x L in mm	14 x 100 8 x 66 11 x 92 13 x 90 13 x 100
max. RCF ²⁾	2,773 2,773 2,808 2,808 2,808
radius in mm	155 155 157 157 157
Cat. No.	-²⁾ blood collection tubes / urine tubes



Adapter	
boring Ø x L in mm	14.6 x 78 14.6 x 78 14.6 x 78 14.6 x 78 14.6 x 78
vessels per rotor	60 60 60 60 60
Cat. No.	0701 0701 - - -



- 1) For cooled versions: Lowest temperature achievable with precooling and max. speed.
- 2) Please note that the RCF values indicated refer only to rotor performance. The max. permissible RCF of tubes used should be verified with the individual manufacturers.
The max. RCF for glass tubes annotated with footnote 2) is 4,000.
- 16) Packaging unit 10 pieces.
- 21) Adapter must be loaded as illustrated.

SWING-OUT ROTOR, 2-PLACE | 1760

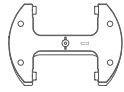

Rotor

max. RPM max. RCF	4,000 min ⁻¹ 2,397
max. capacity	10 plates
run-up run-down, braked in sec	30 23
angle max. noise level	90° 54 dB (A)
temperature in °C ¹⁾	-8
Cat. No.	1760

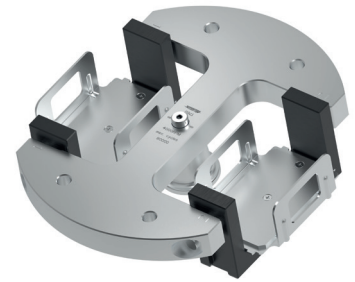

Plates

W x D x H in mm	128x86x15	128x86x17.5	128x86x22	128x86x44.5	128x86x46	128x86x83	84x59x11	124x82x20	-
capacity in ml	-	-	-	-	-	-	-	-	0.2
max. RCF ²⁾	2,397	2,397	2,397	2,397	2,397	2,397	2,397	2,397	2,397
radius in mm	134	134	134	134	134	134	134	134	134
Cat. No.	MTP	MTP	CP	DWP	MS	QP	Microtest plates	PCR plate	PCR strips



Bucket

boring Ø x L in mm	-	-	-	-	-	-	-	-	-
plates / strips per rotor	10	8	6	2	2	2	4	2	48 x 8
Cat. No.	1753-A	1753-A	1753-A	1753-A	1753-A	1753-A	1753-A	1753-A+1485	1753-A+1485

SWING-OUT ROTOR, 2-PLACE | 1770

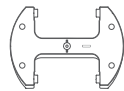

Rotor

max. RPM max. RCF	5,100 min ⁻¹ 3,926
capacity in ml	10 plates
run-up run-down, braked in sec	65 30
angle temperature in °C ¹⁾	90° -3
Cat. No.	1770



Bucket

lid bioseal [®]	4627
Cat. No.	4745

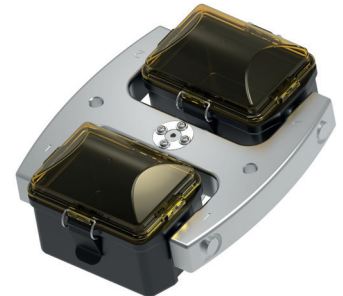

Plates

W x D x H in mm	128x86x15	128x86x17.5	128x86x22	128x86x44.5	128x86x46	128x86x83	84x59x11	124x82x20	-
Ø x L in mm	-	-	-	-	-	-	-	-	0,2
max. RCF ²⁾	3,926	3,926	3,926	3,926	3,926	3,926	3,926	3,926	3,926
radius in mm	135	135	135	135	135	135	135	135	135
Cat. No.	MTP	MTP	CP	DWP	MS	QP	Microtest plates	PCR plate	PCR strips



Removal frame

boring Ø x L in mm	-	-	-	-	-	-	-	-	-
plates / strips per rotor	10	8	8	2	2	2	4	2	24 x 8
Cat. No.	4626	4626	4626	4626	4626	4626	4626	4626 + 1485	4626 + 1485

ANGLE ROTOR, 6-PLACE | 1720



Rotor

max. RPM	ROTINA 380 380 R	10,000 min ⁻¹ 11,000 min ⁻¹
max. RCF		13,528 16,369
max. capacity		6 x 94 ml
run-up / run-down, braked in sec		39 / 36 45 / 44
angle max. noise level		45° 59 dB (A)
temperature in °C ¹⁾		+1

Cat. No.	1720
-----------------	-------------

Vessels																
capacity in ml	1.5	2.0	15	25	50	94	7.5 – 8.2	9 – 10	8.5 – 10	15	50	10	30	50	85	
Ø x L in mm	11 x 38	11 x 38	17 x 100	24 x 100	34 x 100	38 x 102	15 x 92	16 x 92	16 x 100	17 x 120	29 x 115	16 x 80	26 x 95	29 x 107	38 x 106	
max. RCF ²⁾	ROTINA 380	12,969	12,969	12,745	12,410	13,304	13,528	12,745	12,745	12,745	13,081	12,745	12,410	12,410	12,969	13,528
max. RCF ²⁾	ROTINA 380 R	15,692	15,692	15,422	15,016	16,098	16,369	15,422	15,422	15,422	15,828	15,422	15,016	15,016	15,692	16,369
radius in mm	116	116	114	111	119	121	114	114	114	117	114	111	111	111	116	121
Cat. No.	microliter tubes	tubes²⁾				blood collection tubes / urine tubes				tubes with screw cap						

Adapter															
boring Ø x L in mm	11.4 x 39	11.4 x 39	17.5 x 91.5	26 x 85	35 x 89	38.4 x 89.3	17.5 x 91.5	17.5 x 91.5	17.5 x 91.5	17 x 106	29.8 x 96.7	16.5 x 74	26 x 85	29 x 92	38.4 x 89
vessels per rotor	24	24	6	6	6	6	6	6	6	6	6	12	6	6	6
Cat. No.	1449	1449	1451	1447	1463	-	1451	1451	1451	1466	1454	1448	1447	1446	-

Vessels		
capacity in ml	94	
Ø x L in mm	38 x 102	
max. RCF ²⁾	ROTINA 380	13,528
max. RCF ²⁾	ROTINA 380 R	16,369
radius in mm	121	
Cat. No.	-	

Adapter	
boring Ø x L in mm	38.4 x 89
vessels per rotor	6
Cat. No.	-

1) For cooled versions: Lowest temperature achievable with precooling and max. speed.

2) Please note that the RCF values indicated refer only to rotor performance. The max. permissible RCF of tubes used should be verified with the individual manufacturers. The max. RCF for glass tubes annotated with footnote 2) is 4,000.

ANGLE ROTOR, 6-PLACE | 1792



Rotor	
max. RPM	ROTINA 380 380 R 10,000 min ⁻¹ 11,000 min ⁻¹
max. RCF	13,640 16,504
max. capacity	6x94 ml
run-up run-down, braked in sec	40 / 37 48 / 44
angle max. noise level	45° 59 dB (A)
temperature in °C ¹⁾	+4
Cat. No.	1792

+	lid bioseal⁵⁾
Cat. No.	INCLUSIVE

Vessels																
capacity in ml	1.5	2.0	15	25	50	94	7.5 – 8.2	9 – 10	10	8.5 – 10	5	15	50	10	30	
Ø x L in mm	11x38	11x38	17x100	24x100	34x100	38x102	15x92	16x92	15x102	16x100	17x59	17x120	29x115	16x80	26x95	
max. RCF ²⁾	ROTINA 380	13,081	13,081	12,857	12,522	13,416	13,640	12,857	12,857	12,857	12,857	12,745	13,081	13,304	12,857	12,522
max. RCF ²⁾	ROTINA 380 R	15,828	15,828	15,557	15,151	16,233	16,504	15,557	15,557	15,557	15,557	15,422	15,828	16,098	15,557	15,151
radius in mm	117	117	115	112	120	122	115	115	115	115	114	117	119	115	112	
Cat. No.	microliter tubes	tubes²⁾					blood collection tubes / urine tubes				-	tubes with screw cap				

+															
Adapter															
boring Ø x L in mm	11.4x39	11.4x39	17.5x92	26x85	35x89	38.2x89.6	17.5x92	17.5x92	17.5x92	17.5x92	17x51	17x106	29.8x97	16.5x74	26x85
vessels per rotor	24	24	6	6	6	6	6	6	6	6	6	6	6	12	6
Cat. No.	1449	1449	1451	1447	1463	-	1451	1451	1451	1451	1476	1466	1454	1448	1447

Vessels			
capacity in ml	50	85	
Ø x L in mm	29x107	38 x 106	
max. RCF ²⁾	ROTINA 380	13,081	13,640
max. RCF ²⁾	ROTINA 380 R	15,828	16,504
radius in mm	117	122	
Cat. No.	tubes with screw cap		

+		
Adapter		
boring Ø x L in mm	29x92	38.2x89.6
vessels per rotor	6	6
Cat. No.	1446	-

1) For cooled versions: Lowest temperature achievable with precooling and max. speed.
 2) Please note that the RCF values indicated refer only to rotor performance. The max. permissible RCF of tubes used should be verified with the individual manufacturers. The max. RCF for glass tubes annotated with footnote 2) is 4,000.
 5) Tested by TÜV in conformity with DIN EN 61010, section 2-020.

— ANGLE ROTOR, 30-PLACE | 1789-A



Rotor

max. RPM max. RCF	15,000 min ⁻¹ 24,400 min ⁻¹
max. capacity	30 x 2 ml
run-up run-down, braked in sec	24 24
angle max. noise level	45° 60 dB (A)
temperature in °C ¹⁾	+4

Cat. No.	1789-A
-----------------	---------------



Lid bioseal[®], phenol-resistant

Cat. No.	
-----------------	--

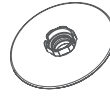

INCLUSIVE



Vessels

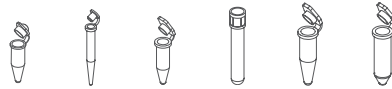

capacity in ml	0.2	0.4	0.5	0.8	1.5	2
Ø x L in mm	6x18	6x45	8x30	8x45	11x38	11x38
max. RCF ²⁾	24,400	24,400	24,400	24,400	24,400	24,400
radius in mm	97	97	97	97	97	97

Cat. No.	microliter tubes					
-----------------	-------------------------	--	--	--	--	--



Adapter

boring Ø x L in mm	6x40	6x40	8x40	8x40	10.2x19.3	11.2x40.9
vessels per rotor	30	30	30	30	30	30

Cat. No.	2024	2024	2023	2023	2031⁷⁾	-
-----------------	-------------	-------------	-------------	-------------	--------------------------	----------

- 1) For cooled versions: Lowest temperature achievable with precooling and max. speed.
- 2) Please note that the RCF values indicated refer only to rotor performance. The max. permissible RCF of tubes used should be verified with the individual manufacturers. The max. RCF for glass tubes annotated with footnote 2) is 4,000.
- 5) Tested by the TÜV in conformity with DIN EN 61010, section 2-020.
- 7) For centrifugation at high speeds, we recommend to use form-fitting, phenol-resistant adapters. Cat. No. 2031.
- 17) Packaging unit 15 pieces.

CERTIFICATIONS / REGISTRATIONS

Product certification:



Product registration:



according to regulation (EU) 2017/746

Company certifications:



DIMENSIONS

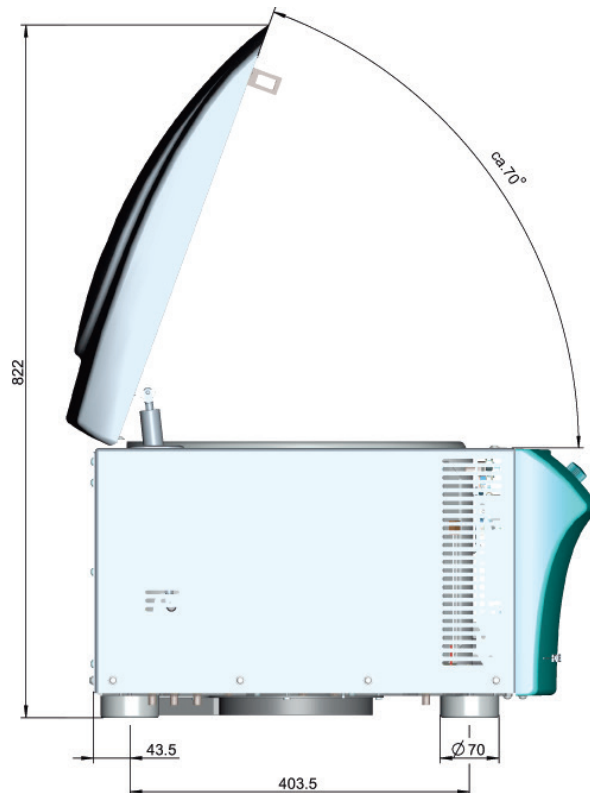

DIMENSIONS

