

Elmasonic Accessory - Elma Mutebox

Noise protection box

- Noise of the ultrasonic cleaning unit operated in the mute box is reduced by max. 85
- vapors are exhausted via a silenced drain, so that no heat or moisture builds up inside the box.
build-up of moisture inside the box
- laterally arranged halogen lamps
- Stainless steel jacket
- Product contents:

Elma Mutebox ML: 1x Elma Mutebox ML, 1x Bottom tray with gland plate, 1x Power supply unit, 1x Manual

Elma Mutebox XL: 1x Elma Mutebox XL, 2x Bottom tray with gland plate, 1x splash plate, 1x Power supply unit, 1x Manual

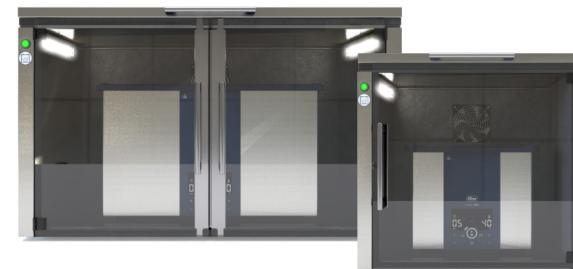

Ultrasonic devices not included in the scope of delivery

Unit size	10	20	30	40	60	100	120	180	70	80	150	200	300
Size	ML								XL				
Order number	1111901								1123006				
Suitable for unit size	10	20	30	40	60	100	120	180	70	80	150	200	300
• Elmasonic Easy	•	•	•	•	•	•	•	•					•
• Elmasonic Select			•	•	•	•	•	•		•	•		•
• Elmasonic P			•		•		•	•	•				•
• Elmasonic xtra TT			•		•		•					•	

Product Information



Elmasonic Accessory - Elma Mutebox

Noise protection box

Technical Data

Unit size	10	20	30	40	60	100	120	180	70	80	150	200	300
Ext. Dimensions W / D / H (mm) (Lid and door closed)	545 / 530 / 525								860 / 605 / 525				
Ext. Dimensions W ₁ / D ₁ / H ₁ (mm) (Lid and door open)	555 / 975 / 1015								860 / 975 / 1085				
Int. Dimensions W ₂ / D ₂ / H ₂ (mm)	430 / 380 / 445								710 / 450 / 445				
Weight (kg)	18,9								26,2				
Mains voltage (V~)	100 - 240												

Elmasonic Accessory - Elma Mutebox

Noise protection box

Dimension definition

External dimensions
(Lid and door closed)

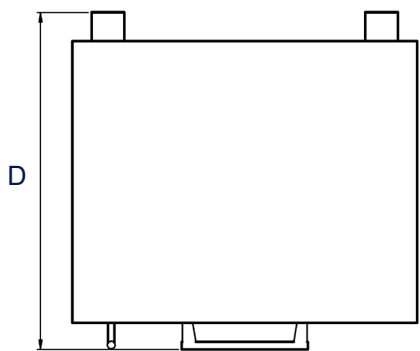
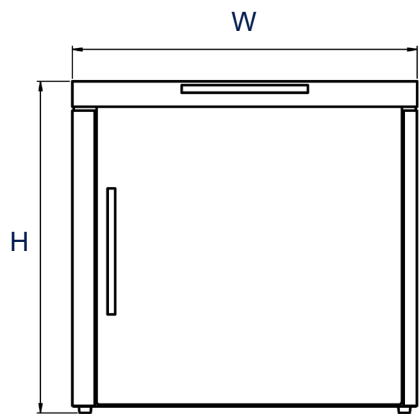

Internal dimensions

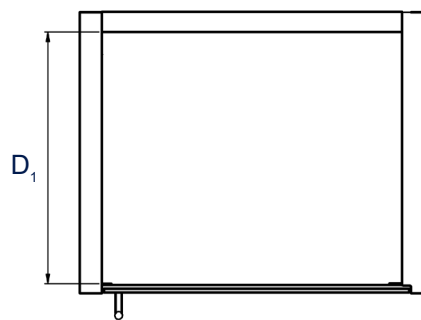
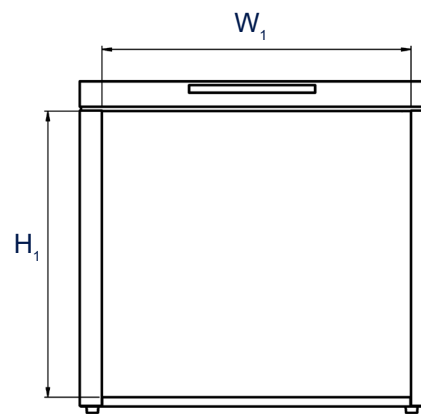

External dimensions
(Lid and door opened)

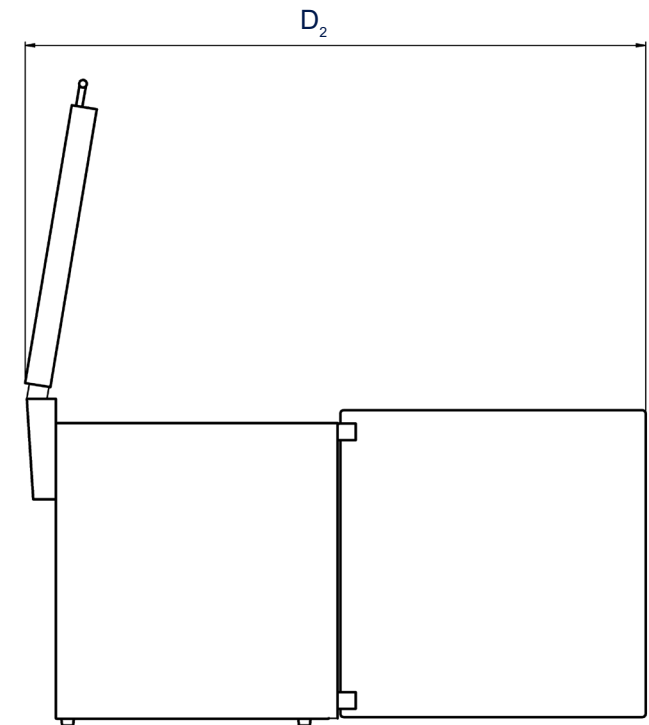
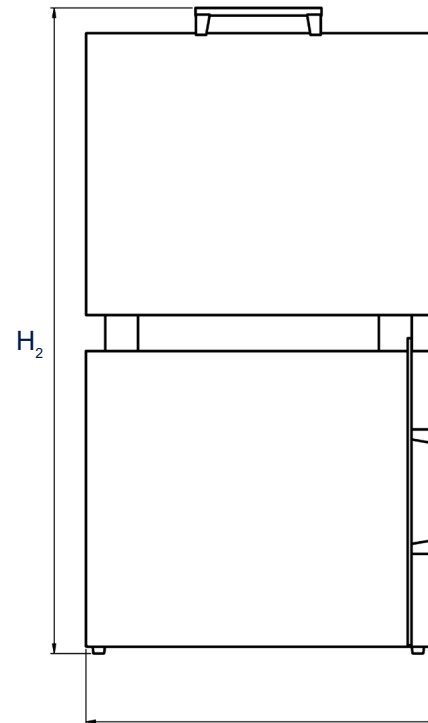

The drawings are meant as a visualization aid and are not true to scale.

Technical specifications serve as orientation values and are subject to tolerances due to production and manufacturing. Proper operation can only be guaranteed when using original Elma accessories.